

A black and white photograph of a person running on a paved path. The person is wearing dark leggings and running shoes. In the background, a dog is visible, and the scene is slightly blurred to suggest motion.

„Take the RISC!“

**CaptainCasa
Enterprise Client**

XII. Community Meeting

Agenda

- 10:00 Opening / Positioning / 2017 in a Nutshell
- 10:20 Issues around mobile applications
- 10:45 Absolute positioning / z-layer arrangement
- 11:00 CaptainCasa & PNA
- 11:40 Coffee Break
- 11:50 Entering the SAP Cloud
- 12:30 Page Bean Components - New application controls
Page Bean Components - DOF reloaded
- 13:00 Lunch Break
- 13:45 Wow!ing your dialogs
- 14:15 SpringBoot
- 14:35 HTML inside Java
- 14:50 Isolating User Activities
- 15:10 Security Issues
- 15:30 Coffee Break
- 16:00 CaptainCasa Organization
Roadmap 2018 / Discussion

Still the same old picture

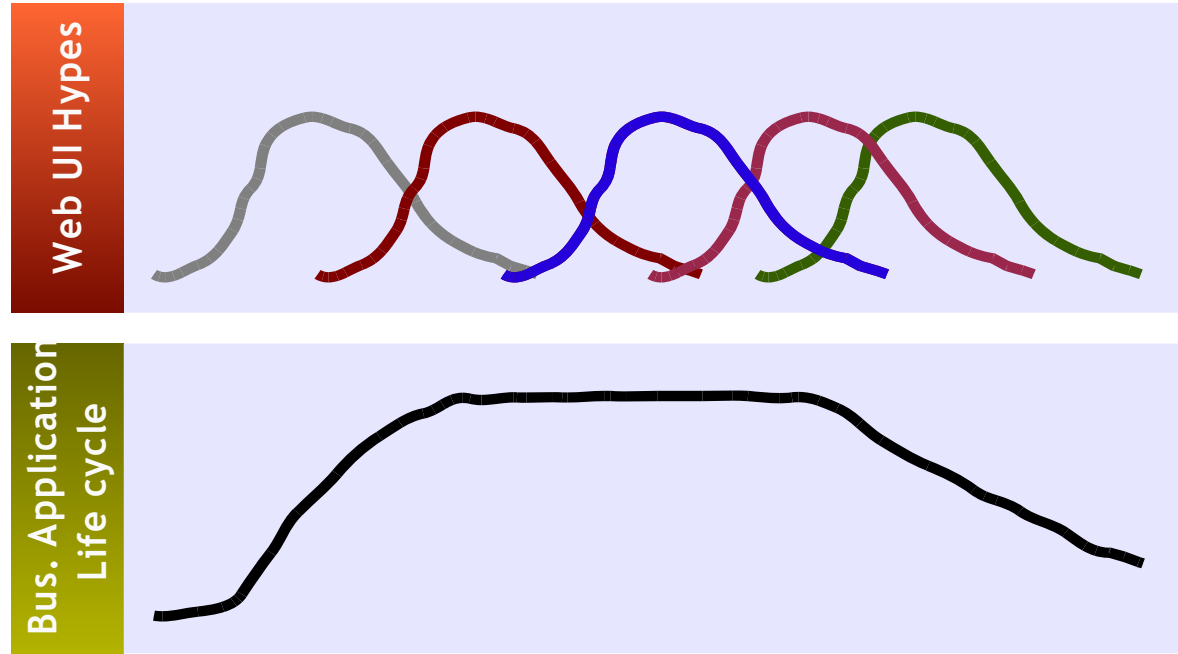

Where we are

Roadmap 2017

Do not touch!

Active Product

Hot Product

Business Client

Swing

JavaFX

RISC-HTML

Application Components

???

Activities 2017

Do not touch!

Active Product

Hot Product

Business Client

Swing

JavaFX

RISC-HTML

Application Components

Some components...

Activities 2017

Do not touch!

Active Product

Hot Product

Business Client

Swing

JavaFX

RISC-HTML

Application Components

Some components...

Activities 2017

- Do not touch!
- Active Product
- Hot Product

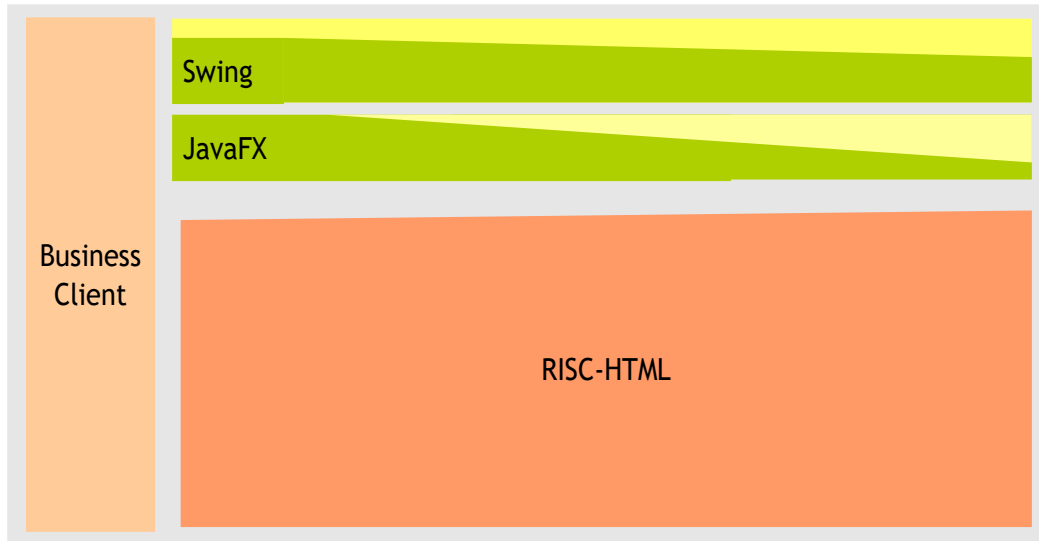

+

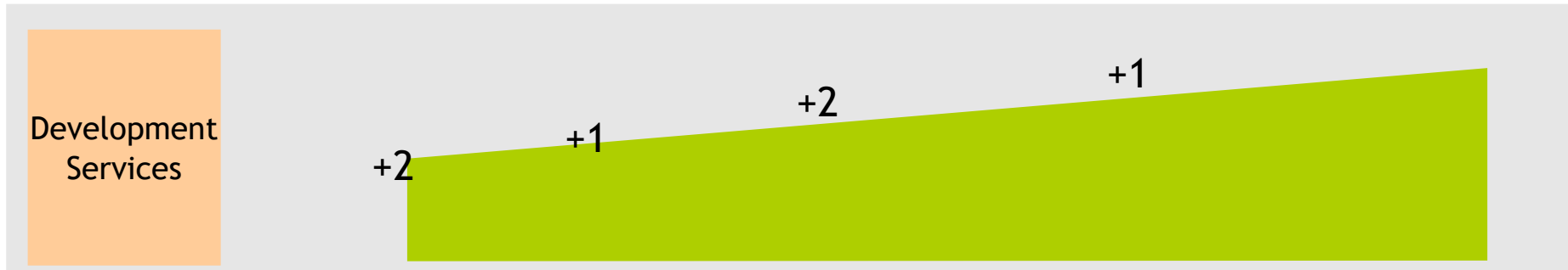
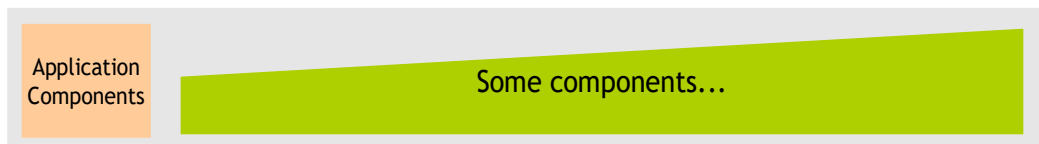

CaptainCasa

- Deutschland
 - Björn Müller
 - Dr. Ulrich Hirsch
- Bulgarien
 - Evolution IT
 - Nikolay Nikolov
 - Rostislav Gardinov
 - Alexander Krastev
 - Yulian Savov
 - Ivan Tonchev

Projects

- Cloud based Access Control Management
- Contract document management
- MES Planning Board („Fertigungsleitstand“)
- BPMN Modelling Tool

RISC Browser Architecture

Complex Instruction Set
Client
CISC

Reduced Instruction Set
Client
RISC

Framework

#Elements
#Attributes
#CSS

Rendering
„Algorithmic“

Control Libraries
(.js)
based
On
Nucleus Elements

Rendering „Execution“

Micro Kernel

„2“ El.

RISC-HTML in Community

- All new customers / projects 100% RISC based
- Swing users
 - Swing is „Legacy Technology“ - and sometimes it's not simple to kick it out...
 - Transfer-to-RISC projects with very good results
 - Good level of compatibility!
 - Performance on Chrome, Edge, Firefox excellent, on IE 10,11 ok
- FX user
 - ...luckily HTML pressure is coming from customer site! ;-)

Positioning

Powerful HTML Rich Client Framework for demanding Business Applications

Rock solid, industry-stable
Cross browser/device
High performance
Overcoming HTML restrictions

Simple development, Java-only
Huge component library
Based on standards

Using RISC-HTML

RISC-HTML outside Community

- Direct competitors
 - Vaadin
- Indirector competitors
 - AngularJS
 - ReactJS
 - ...
 - Client side development \Leftrightarrow Server side development

Mobile Applications

Positioning

- CaptainCasa requires some server processing
 - „Stand alone“ is only possible if server can run on local device
 - Industry Terminals
 - Windows Tablets
 - Direct usage of JS control library...
 - Experience: JS quite far away from Java...

Scaling

- Query Parameter:

&ccscale=1.25

Image Resolution

- By default
 - Image size == physical size of Image
- But
 - Explicit setting of WIDTH/HEIGHT
 - Implicit setting by file name
 - /images/save_16x16.png

Sliding through lists

- Implementation SCROLLPANE
 - Not too long lists...
 - Soft touch scrolling
- Implementation FIXGRID
 - No restrictions
 - Touch scrolling

Nice controls

- SHIFTCONTAINER
- SLIDECONTAINER

Keyboard Input

- By default: managed by browser
- Style
 - switch CC keyboard support on via style parameter

Adaptive Layout

- ROWADAPTIVEAREA
- ...

SIZETRANSFER

- PANE
SIZETRANSFER
- Sehr nützlich: ROWPAGEBEANINNERPART

Animations

- „Curtain-based“ animations
- Sizing based animations

Absolute Positioning / Layering

Available controls

- Container Management
 - OVERLAYAREA
 - OVERLAYAREAITEM
- Drawing
 - PAINTAREA
 - PAINTAREAITEM
 - PAINTAREALINEITEM
- ...actually OVERLAYAREA is just a functionally restricted version of PAINTAREA...

PAINTAREAITEM

- New functions
 - ITEMID
 - LINEIDSENDING/STARTING
 - BOUNDSANCHOR

Access Control Management

Current Service Structure

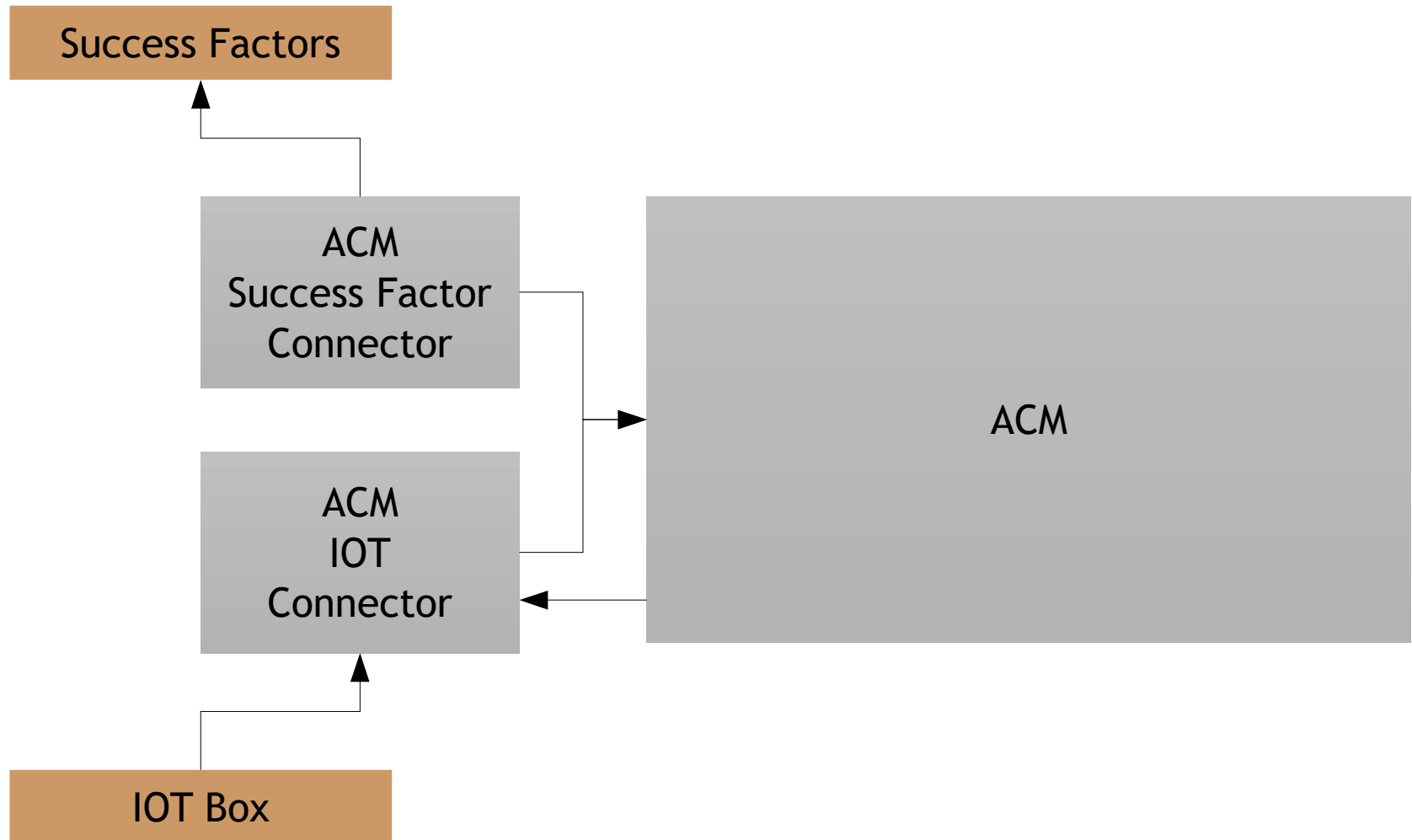

Current Service Structure

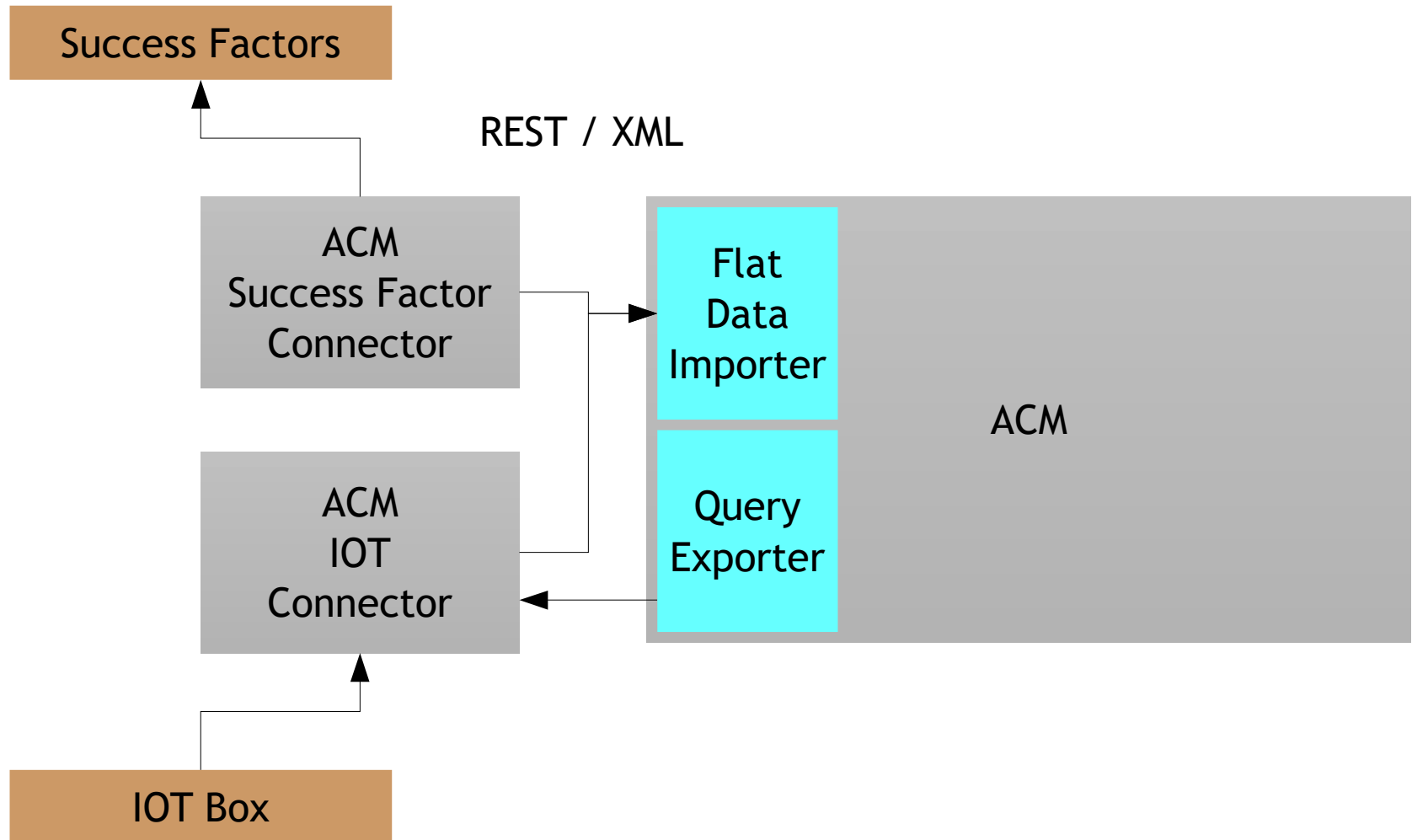

PageBean Components

PageBean Components

- == logically the same as normal PageBeans
- But
 - all required information packaged with jar-file
 - Layout (.jsp)
 - Resources (.png, ...)
 - Translations (.properties)

Layout Editor

- Much simpler editing of page beans...

Usage

- CCDataTree
- CCTextDiff

DOF Data Object Framework

- Fast development of boring CRUD screens
- High level of extensibility
 - UI design level
 - Logical level

Security Issues

XSS - Cross Site Scripting

- Encoding aller String Inhalte by default im Client

```
656 | this.RISCsetOpacity = function(value) { this.m_dome.style.opacity = val
657 | this.getDome = function() { return this.m_dome; };
658 | this.setText = function(value,withConversion)
659 | {
660 |     if (value != null)
661 |     {
662 |         if (withConversion != false)
663 |         {
664 |             value = CCValueManager.convertHTMLTextToPlainText(value);
665 |         }
666 |         this.m_dome.innerHTML = value;
667 |     }
668 |     else
669 |     {
670 |         this.m_dome.innerHTML = "";
671 |     }
672 | };
674 | this.setTextAlign = function(value)
    | {
```

```
CCValueManager.convertHTMLTextToPlainText = function(value)
{
    if (value == null) return null;
    if (value.replace == null) return value;
    var result = value.replace(/&/g, "&amp;")
                    .replace(/>/g, "&gt;")
                    .replace(/</g, "&lt;")
                    .replace(/"/g, "&quot;")
                    .replace(/'/g, "&#x27;")
                    .replace(/\\/g, "&#x2F;");
    result = CCValueManager.replaceAll(result, "\n", "<br>");
    return result;
};
```

Explicit Sanitizing by „Free Style“ Components

- TEXTPANE
- SIMPLEHTMLEDITOR
- Sanitizing based on Google JavaScript algorithm
 - Positive list of HTML4 elements

By the way...: SQL Injection?

- For all JDBC users:

What is the ultimate way of protecting your DB-code against SQL injection?

Session ID Hijacking

- Switch SecurityFilter on! (!!!)

-

```
55  ---
56  <filter>
57    <filter-name>org.eclnt.jsfserver.util.SecurityFilter</filter-name>
58    <filter-class>org.eclnt.jsfserver.util.SecurityFilter</filter-class>
59  </filter>
60
84  <filter-mapping>
85    <filter-name>org.eclnt.jsfserver.util.SecurityFilter</filter-name>
86    <url-pattern>*.jsp</url-pattern>
87  </filter-mapping>
88  </>
```

File access on server side

- Not allowed file access...
- CaptainCasa
 - FileManager
 - Explicit configuration of directories that can be accessed

PASSWORD Input

„Isolating“ User Activities

BLOCKABLEAREA

Modal Popup

- `setLeftTopReference*(id)`
 - Top
 - Bottom
 - Centered
- `setHighlightReference()`
- `setOpacity()`
- `setScreenBackground()`

Sammelsurium

CALENDAR/FIELD with background info

Dezember						
Mo	Di	Mi	Do	Fr	Sa	So
				1	2	3
4	5	6	7	8	9	10
11	12	13	14	15	16	17
18	19	20	21	22	23	24
25	26	27	28	29	30	31
					Heute	
2017						

Rounding

Some mall rounded icons



Some big rounded icons



Some big rounded icons

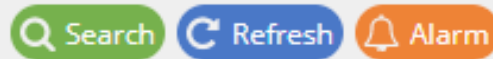

BLOCKABLEAREA

Number	Text	UoM
530000	Article 0	kg
530001	Article 1	kg
530002	Article 2	kg
530003	Article 3	kg
530004	Article 4	kg
530005	Article 5	kg
530006	Article 6	kg
530007	Article 7	kg
530008	Article 8	kg
530009	Article 9	kg
5300010	Article 10	kg
5300011	Article 11	kg
5300012	Article 12	kg
5300013	Article 13	kg
5300014	Article 14	kg
5300015	Article 15	kg
5300016	Article 16	kg
5300017	Article 17	kg
5300018	Article 18	kg

Create new article

Number

Text

Unit of Measure

DRAWAREA

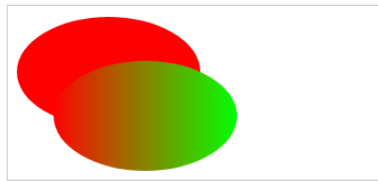
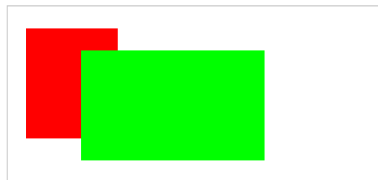

Hello world!

Hello world!

Layout Editor - Search

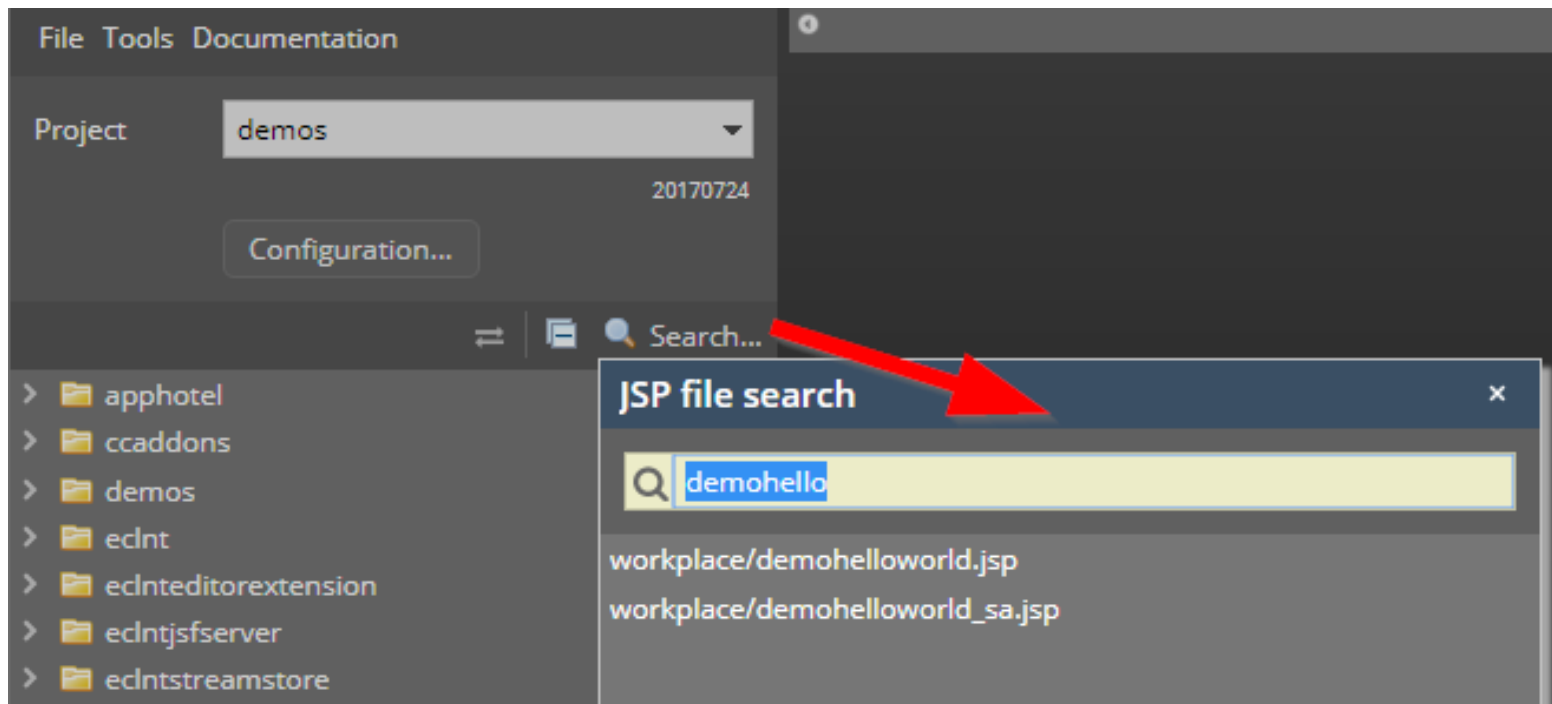

SAP Icon Font

The screenshot displays the SAP Fiori design tool interface. On the left, a 'Components' sidebar lists various UI elements, with 'SAP Font Icon' highlighted. The main workspace shows the 'SAP Font Icon' component with three tabs: 'Demo', 'Layout XML', and 'Server side Java Code'. The 'Demo' tab is active, showing the component's visual representation. Below the component name, there are several rows of icons, including a calendar icon, a diamond icon, and a warning icon. The text 'Image "/sapicon(cccc,#rrggbb,ss)"' is displayed below the icons, indicating the component's image source and parameters.

Components

- Invokers
 - Various Buttons
 - Links
 - Vertical Links
 - Button - Click/DoubleClick
 - Button - Image Sizing
 - Awesome Font Icon
 - SAP Font Icon**
 - Font Icons - List of Icons
- Combo Box and List
- Text Input/Output
- Check Box & Radio Button
- Images
 - Image Output
 - Animated Images
 - Image Mirroring
 - Image Sizing
 - Image Hex Data
 - Image (Double) Click
 - Image with mapped areas

SAP Font Icon

Demo | Layout XML | Server side Java Code

Component FONTICON

Image "/sapicon(cccc,#rrggbb,ss)"

Flexible TREENODE

>	Parent 0	x
▼	Parent 1	x
○	Child 0	x
○	Child 1	x
○	Child 2	x
>	Parent 2	x
>	Parent 3	x

Color Picker

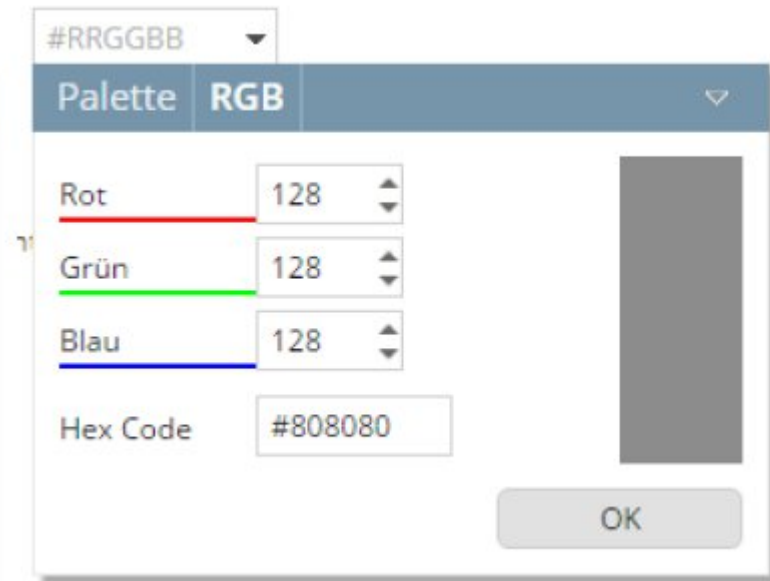
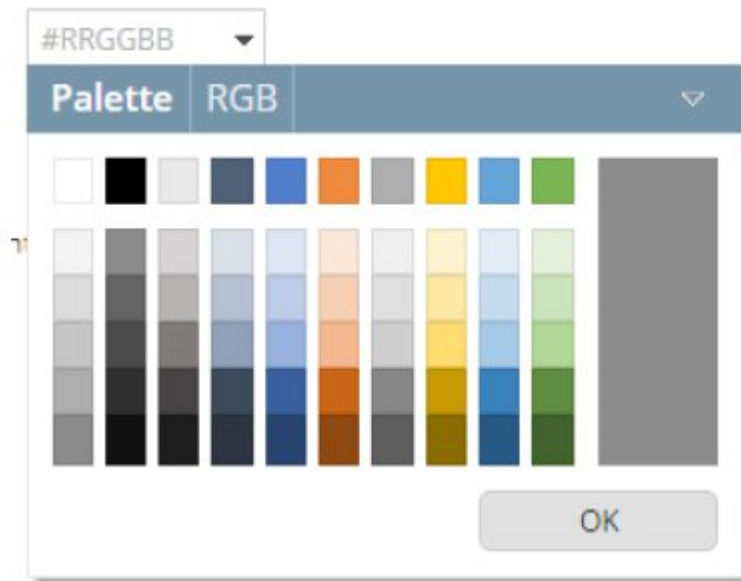

Tips und Tricks!

Tips und Tricks

- Übersetzungstoleranz bei Labeln
- Expression Manager
- pbx()

Roadmap 2018

Shortcuts to using CaptainCasa

- Frameworks
 - Maven
 - Spring Boot
- Development Environment
 - IntelliJ
 - (NetBeans?)
- Simplify first steps
 - Deliver basic scenarios

UI Components / Features

- Right to Left
- PageBeanComponents
 - DOF!
 - ...and others!

Services

- Provide solid service packages
 - CaptainCasa DE/BG
 - Partner Network

Roadmap 2018

RISC Client	
Swing	(Maintenance)
FX	(Maintenance)
PageBean Components	
Services	